



NCCM[®]

Roll Technology

Next level nonwoven roll technology solutions

QUALITY. SERVICE. COMMITMENT.

NCCM Company, a family-owned business, manufactures high-value and custom-engineered nonwoven rolls for the OEM, metals, automotive, and industrial markets. Our nonwoven rolls are designed to replace traditional roll coverings, like rubber, urethane, other nonwovens, various fabrics, carbide coatings, and have features and properties that no other rolls offer. We offer the original yellow roll made with exclusive and proven 3M materials and proprietary technology.

Our goal is to **lead the industry in the right direction** by providing cutting edge and high value-add products and services that improve NCCM customers' productivity and product quality while decreasing the cost of production and environmental footprint. We accomplish this through trust, strong relationships, and advanced roll technologies and approach our business calling with a transformative, philanthropic mindset.



GLOBAL LOCATIONS

NCCM services customers around the world. Our global headquarters and nonwoven cover manufacturing is located in River Falls/WI, United States. We operate roll manufacturing and service centers in Dearborn, MI/United States, McKees Rocks, PA/United States, Barcelona/Spain, and Shanghai/China. The subsidiaries provide roll and shaft manufacturing, engineering, and sales plus a 360° best-in-class service to our customers in the core markets of North America, Europe, and Asia. A comprehensive network of value-added resellers (VARs) and regional sales offices complete our strong local presence on five continents.

NORTH AMERICA

NCCM River Falls

Headquarters
2555 Prairie Drive
River Falls, WI 54022
(+1) 715.425.5885
sales@nccmco.com

NCCM McKees Rocks

401 Sproul Street
McKees Rocks, PA 15136
(+1) 412.771.2200

NCCM Dearborn

8526 Brandt Street
Dearborn, MI 48126
(+1) 313.584.9696

CHINA | ASIA

NCCM Shanghai

Huangpu, 200020
Shanghai | CHINA
sales@nccmco.com
尼柯姆辊业(上海)有限公司
上海市淮海中路 755号
新华联大厦东楼1940室 邮编: 200020

EUROPE | EMEA

NCCM Barcelona

Montornés del Valles, 08170
Barcelona | SPAIN
Phone: +34 935-181-856
sales@nccmco.com
eu-sales@nccmco.com

INTERNATIONAL VALUE-ADD RESELLERS AND ROLL SERVICE CENTERS NETWORK

20+ VARs to service your rolls locally in all major automotive and metals processing markets around the globe.

INTERNATIONAL SALES AGENCIES

Sales agents in Mexico, Canada, the Czech Republic, Germany, Turkey, France, and the United Kingdom.

Contact sales@nccmco.com to connect with your local sales representative, VAR, sales agent, distributor, or roll service center.



For more detailed information, scan the QR code or visit our website at NCCMCO.com

NCCM® Premier Yellow

The Proven High-Value Nonwoven Roll

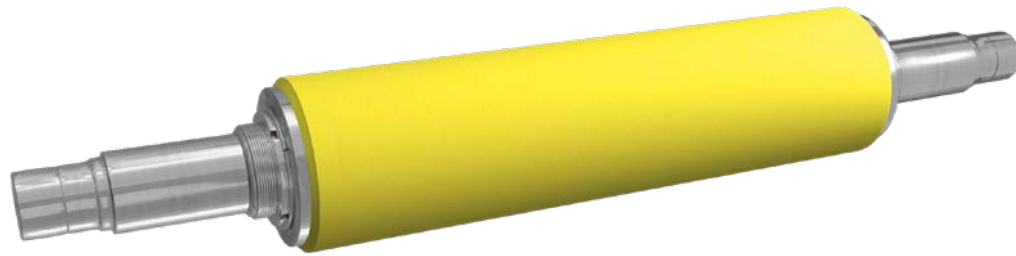

The yellow original—outstanding in technical features, performance, and service life

The renowned NCCM® Premier Yellow outperforms any other nonwoven roll globally and has been a world-class benchmark for 25+ years! With applications such as wringing, oiling, de-oiling, blank washing, and more, the Yellow roll is custom-engineered to succeed in multiple industries and applications. Features such as long life, reparability, fluid control, and a high coefficient of friction contribute to the Yellow roll's dominance.

Coefficient of Friction

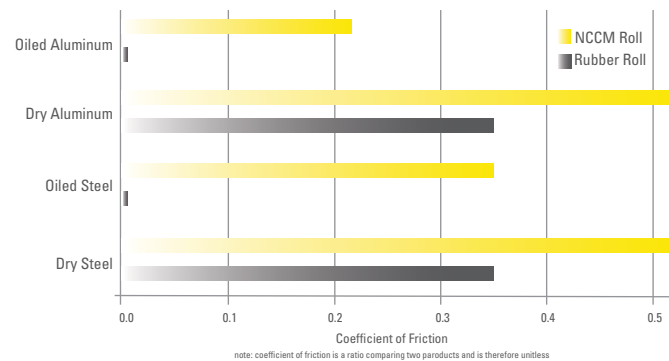

NCCM® Premier Yellow	DENSITIES 3N, 4N, 5N, 6N, 7N, 8N, 9N and 11N	MAX. TEMPERATURE approx. 140°C (284°F)
	SIZES Max. roll size: 647,7mm (25.5") OD; 457,2mm (18") ID Min. roll size: 50,8mm (2") OD; 25,4mm (1") ID	MAX. OPERATING PRESSURE 60N/mm (342 PLI)
FLUIDS Water, oils and many different fluids in the pH range of 2–10. <small>All application parameters are relative to specific applications and do not provide formal guarantees. Please contact an NCCM representative for further insight and questions on sizes, parameters and requirements.</small>		

NCCM® Premier Yellow	FEATURES	BENEFITS
	<ul style="list-style-type: none"> • Longest life • Repairability • Superior fluid control • Highest coefficient of friction • Self-healing • Cut resistant • Porosity 	<ul style="list-style-type: none"> • Reduced replacement cost • Reduced inventory cost • Reduced maintenance cost • Reduced fluid usage/cost • Reduced staining from poor wringing • Reduced defects on coil • Increased line uptime • Increased line speed • Cost effective

Please contact an NCCM representative for additional information on features and benefits.

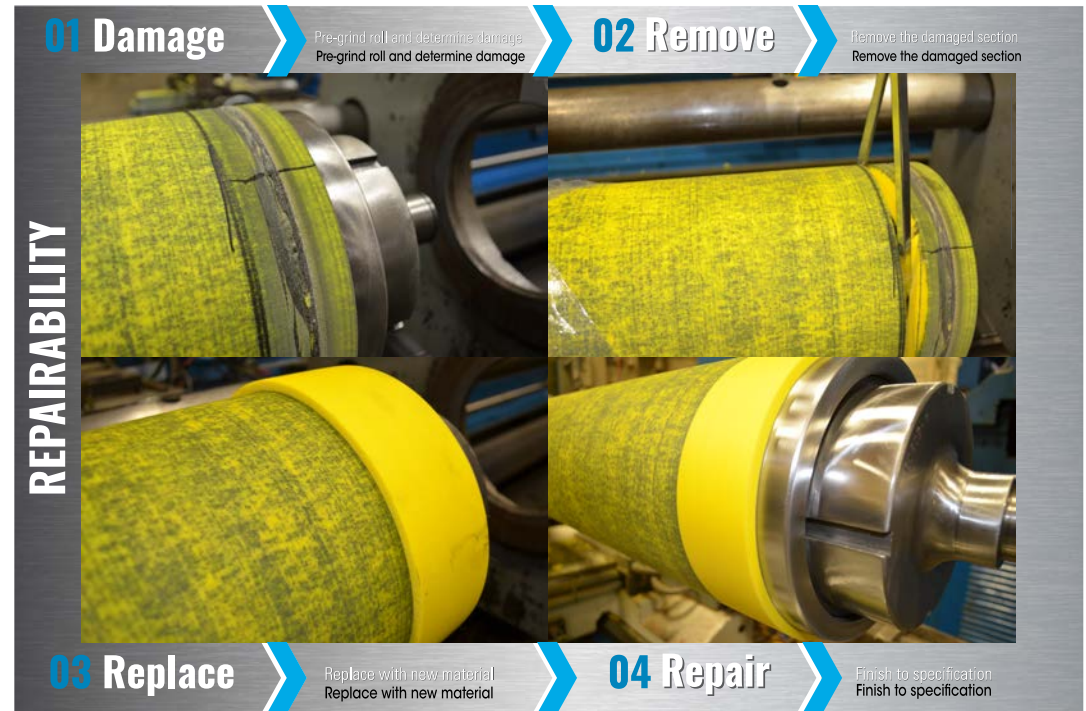

NCCM® PREMIER YELLOW



For more detailed information, scan the QR code or visit our website at NCCMCO.com

NCCM® N-Series

Value-Add Nonwoven Rolls



Custom-engineered for multiple positions in coil and sheet processing

Each of the three NCCM® N-Series products can be used in multiple applications. **NCCM® N2** is set to be the universal option, and this roll is a high-performance alternative to operations, not requiring the supreme performance of the NCCM® Premier Yellow. **NCCM® NT** is the low-pressure pinch/feed, wringer, and vacuum roll of choice, and **NCCM® NS** showcases Soft Touch technology to avoid marking valuable strips or surfaces.

Precision Fluid Control
How an NCCM Nonwoven Roll Works in a Single 360 Rotation

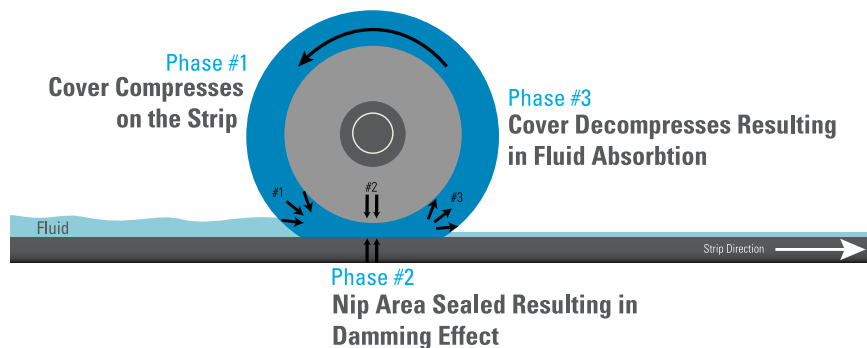

NCCM® N2

The universal option—2 fulfill high-performance friction and fluid control demands

NCCM® N2 is an N-Series high-performance product for a variety of applications. With life far beyond rubber or polyurethane rollers and an excellent performance-to-cost ratio, the NCCM® N2 provides a positive return on investment. Built on world-leading nonwoven roll know-how, this product will take applications requiring friction and fluid control to the next level.

NCCM® NT

The low-pressure alternative—excels in wringer, feeder, and vacuum applications

NCCM® NT is a competitively-priced nonwoven roll meant for low-pressure pinch/feed, wringer, and transport applications. Due to its nonwoven nature, the NCCM® NT possesses high porosity; as a vacuum roll, this feature allows for absorption of fluid and excellent drying.

NCCM® NS

The Soft Touch solution—eliminates scratches and ensures mirror finish surface processing

NCCM® NS delicately handles the most specialized surfaces to reduce material damage and the resulting material waste. If product rejection costs are increasing due to scratches or gouges, NCCM® NS is a worthwhile investment.

NCCM® N2	DENSITIES	MAX. TEMPERATURE
	3N2, 5N2, 6N2, 7N2, 8N2 and 9N2	approx. 140°C (284°F)
NCCM® N2	SIZES	MAX. OPERATING PRESSURE
	Max. rolls size: 647,7mm (25.5") OD; 457,2mm (18") ID Min. roll size: 50,8mm (2") OD; 25,4mm (1") ID	44N/mm (251 PLI)
FLUIDS		
Water, oils and many different fluids in the pH range of 2–10.		
All application parameters are relative to specific applications and do not provide formal guarantees. Please contact an NCCM representative for further insight and questions on sizes, parameters and requirements.		

NCCM® NT	DENSITIES	MAX. TEMPERATURE
	3T, 5T, 6T and 7T VT (vacuum rolls)	approx. 125°C (257°F)
NCCM® NT	SIZES	MAX. OPERATING PRESSURE
	Max. rolls size: 647,7mm (25.5") OD; 457,2mm (18") ID Min. roll size: 50,8mm (2") OD; 25,4mm (1") ID	22N/mm (125 PLI)
FLUIDS		
Water, oils and many different fluids in the pH range of 2–10.		
All application parameters are relative to specific applications and do not provide formal guarantees. Please contact an NCCM representative for further insight and questions on sizes, parameters and requirements.		

NCCM® NS	DENSITIES	MAX. TEMPERATURE
	3NS, 4NS, 5NS, 6NS, 7NS, 8NS, and 9NS	approx. 140°C (284°F)
NCCM® NS	SIZES	MAX. OPERATING PRESSURE
	Max. rolls size: 647,7mm (25.5") OD; 457,2mm (18") ID Min. roll size: 50,8mm (2") OD; 25,4mm (1") ID	50N/mm (286 PLI)
FLUIDS		
Water, oils and many different fluids in the pH range of 2–10.		
All application parameters are relative to specific applications and do not provide formal guarantees. Please contact an NCCM representative for further insight and questions on sizes, parameters and requirements.		

NCCM® N-SERIES

For more detailed information, scan the QR code or visit our website at NCCMCO.com



NCCM® CX-Series

Chemically Resistant Nonwoven Rolls

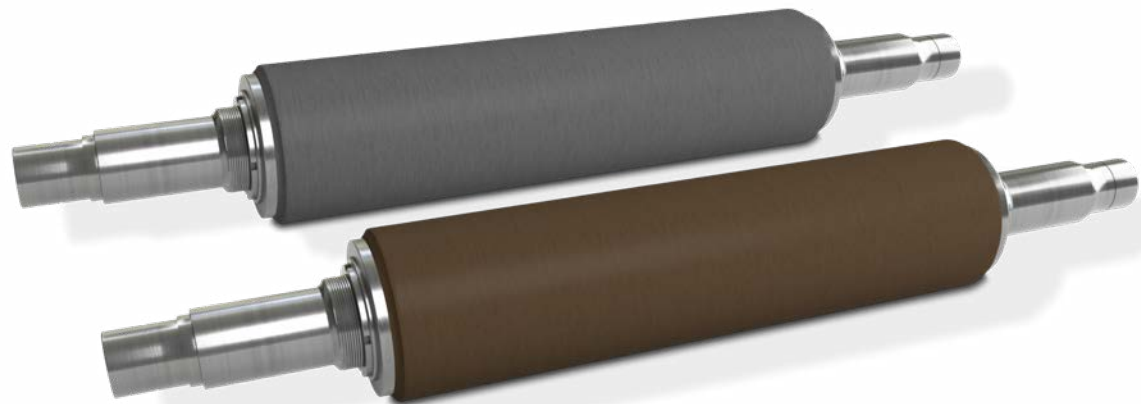

Advanced solutions for caustic, alkaline, and acidic applications

Count on NCCM Company in aggressive environments. Our NCCM® CX-Series mill rolls are ideal for harsh caustic, alkaline, and acidic chemistries. They are specially designed to achieve peak performance in caustic cleaners on tinning, galvanizing, or coil coating lines. Self-healing properties provide cut resistance against strip edge damage, and the wear resistance of our high-tech nonwoven material extends roll life long past traditional rubber coverings. Custom-engineered to specification, they can also significantly contribute to increased productivity and outperform rubber rolls in pickling lines by far.

NCCM® CX	DENSITIES	OPERATIONAL pH
	4CX, 5CX, 6CX and 7CX	pH range 0~14
	SIZES	MAX. TEMPERATURE
	Max. rolls size: 647,7mm (25.5") OD; 457,2mm (18") ID Min. roll size: 50,8mm (2") OD; 25,4mm (1") ID	93°C (200°F)
	MAX. OPERATING PRESSURE	
	13,7N/mm (78 PLI)	
All application parameters are relative to specific applications and do not provide formal guarantees. Please contact an NCCM representative for further insight and questions on sizes, parameters and requirements.		

NCCM® CX-Plus	DENSITIES	OPERATIONAL pH
	5CXP and 7CXP	pH range 0~14
	SIZES	MAX TEMPERATURE
	Max. rolls size: 647,7mm (25.5") OD; 457,2mm (18") ID Min. roll size: 50,8mm (2") OD; 25,4mm (1") ID	116°C (240°F)
	MAX OPERATING PRESSURE	
	17N/mm (98 PLI)	
All application parameters are relative to specific applications and do not provide formal guarantees. Please contact an NCCM representative for further insight and questions on sizes, parameters and requirements.		



NCCM Chemical Wringer Rolls

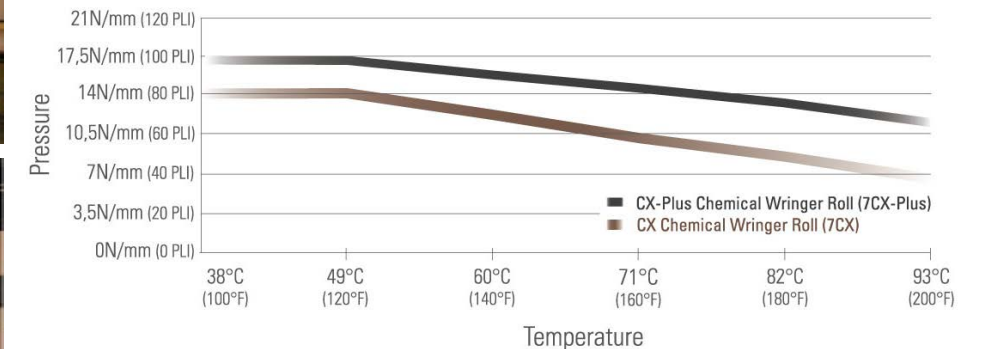

Note: All application parameters are relative to specific applications and do not provide formal guarantees.

NCCM® CX-SERIES

For more detailed information, scan the QR code or visit our website at NCCMCO.com



NCCM® R-Series

Long-Life Nonwoven Table and Bridle Rolls

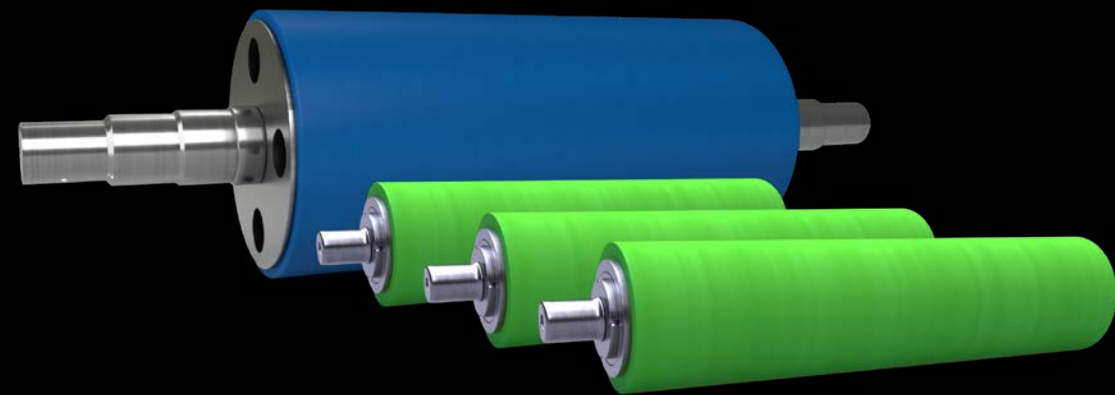

The replacement for rubber and urethane

NCCM® RU

Nonwoven strength and durability at a urethane price point

NCCM® RU nonwoven rolls are newly patented and have been specifically developed to replace the majority of conventional and less demanding rubber and urethane rolls in multiple table, deflector, and conveyor applications. NCCM® RU nonwoven rolls are a high-value proposition due to their outstanding durability and other unique nonwoven product features at a competitive urethane price point. NCCM® RU brings classic NCCM benefits to the table, such as long life, cut resistance, and non-marking qualities. Also, the NCCM® RU has reduced noise on push/pull lines by up to 10 decibels compared to urethane rolls. Best of all, NCCM® RU is sold at a similar price point to urethane and can last up to 5x longer than rubber or urethane. That's new and revolutionary for the roll industry!

NCCM® RU Nonwoven Rolls Can Last Up to 5x Longer than Rubber or Urethane!



NCCM® RU	DENSITY RU single density	WALL THICKNESS approx. 12,7mm (0.5") approx. 19,1mm (0.75")
	OUTSIDE DIAMETER RANGE approx. 101,6–1.219,2mm (4–48")	MAX. FACE WIDTH approx. 2.844,8mm (112")
	OPERATIONAL pH Range 2–10	MAX. TEMPERATURE approx. 90°C (194°F)

All application parameters are relative to specific applications and do not provide formal guarantees. Please contact an NCCM representative for further insight and questions on sizes, parameters and requirements.

NCCM® RK

Consistently high friction over a remarkably long life

NCCM® RK is an extremely long-lasting nonwoven bridle roll meant for highly demanding applications. Strip slippage is often eliminated due to a high coefficient of friction. Custom-engineered for specific applications, a wide range of sizes are available for a variety of bridle applications.

NCCM® RK	DENSITY RK single density	WALL THICKNESS approx. 12,7mm (0.5") approx. 19,1mm (0.75")
	OUTSIDE DIAMETER RANGE approx. 101,6–1.219,2mm (4–48")	MAX. FACE WIDTH approx. 2.844,8mm (112")
	OPERATIONAL pH Range 2–10	MAX. TEMPERATURE 75°C (167°F)

All application parameters are relative to specific applications and do not provide formal guarantees. Please contact an NCCM representative for further insight and questions on sizes, parameters and requirements.

NCCM® R-SERIES

For more detailed information, scan the QR code or visit our website at NCCMCO.com



NCCM® V-Series

Long-Life Nonwoven Wipes and Bars

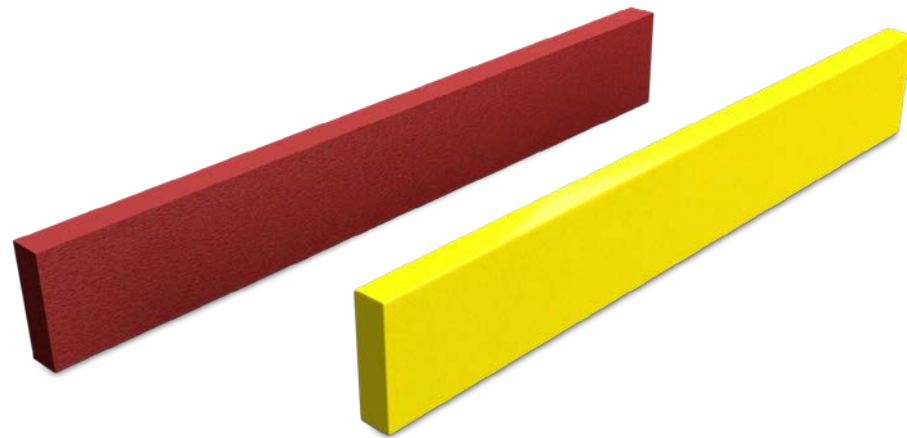

Unique nonwoven technology for sweeping and wiping applications

NCCM® V-Series nonwoven wipes and bars take the place of rubber, felt, or cork products in a variety of material handling applications. As a versatile, high-value solution for consistent and long-lasting performance, the NCCM® V-Series replaces easily-gouged and damaged traditional materials. **NCCM® Wiper Bar II** excels in applications demanding fluid control and squeegee capabilities. **NCCM® Mill Wipe** is an excellent choice for oxide and debris removal, as well as other sweeping, wiping, and cleaning applications. Cost savings are often realized due to the minimization of costly line downtime for traditional bar replacements. In addition, the uniform, even-edged, and long-lasting performance of the NCCM® V-Series increases product processing quality. Compressibility also contributes to NCCM® Mill Wipe and NCCM® Wiper Bar II's success as the material maintains tight and uniform contact with uneven surfaces and varying thicknesses.

NCCM® Wiper Bar II	DENSITIES	PRODUCT THICKNESS	
	soft, medium and hard	3,2mm (1/8")	6,4mm (1/4")
	PRODUCT WIDTH	PRODUCT LENGTH	
	25,4mm–558,8mm (1"–22")	25,4mm–2,794mm (1"–110")	

All application parameters are relative to specific applications and do not provide formal guarantees. Please contact an NCCM representative for further insight and questions on sizes, parameters and requirements.

NCCM® Mill Wipe	DENSITIES	PRODUCT THICKNESS	
	soft, medium and hard	3,2mm (1/8")	6,4mm (1/4")
	PRODUCT WIDTH	PRODUCT LENGTH	
	25,4mm–558,8mm (1"–22")	25,4mm–2,794mm (1"–110")	

All application parameters are relative to specific applications and do not provide formal guarantees. Please contact an NCCM representative for further insight and questions on sizes, parameters and requirements.

NCCM® V-Series Work Roll Application

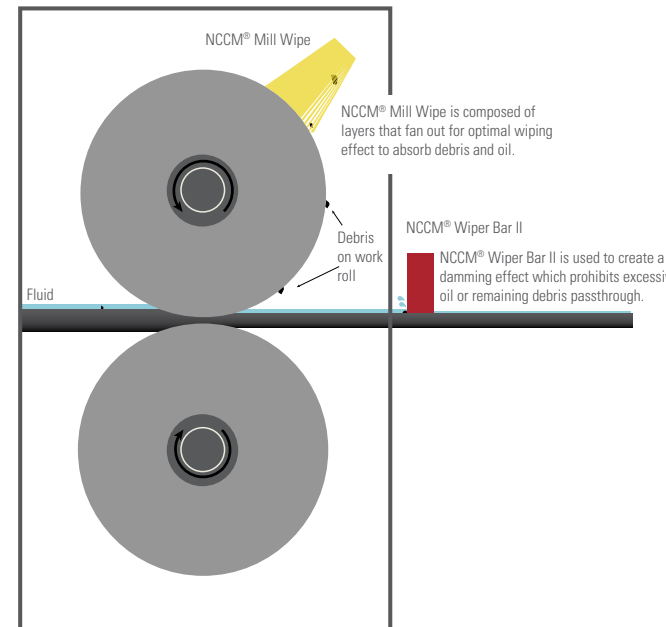

NCCM® Wiper Bar II (red) is a more durable bar for scraping adhered debris or providing a static, solid edge for fluid control. NCCM® Mill Wipe (yellow) is made of nonwoven layers. This contributes to the product's long life; if one layer becomes dirty, simply peel it off to reveal a clean layer. This layered makeup provides the excellent debris sweeping and absorption the product is known for. Both products can be ordered to a specified thickness for a variety of applications.

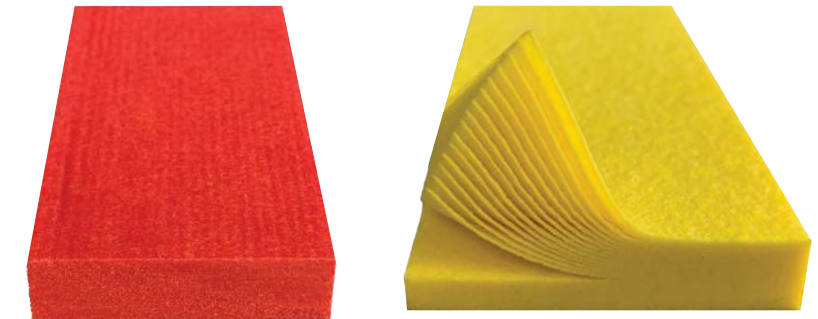

MARKETS

NCCM is the global market leader in nonwoven roll technology and development. The company's high value-add products can be found in various markets, including OEM, metals, automotive, and material handling.

OEM

Manufacturing Technology



World-class from pre-sales to after-sales

The NCCM value for OEMs and machine builders is the in-depth technical design competence we bring to each new roll build based on broad application engineering knowledge. Our service does not end with an order being supplied; our global presence and comprehensive network also provide on-site installation support and local follow-up service for each new roll installed around the world.

Metals

Sheet, Coil, and Tube Processing



Upgrade in process line efficiency you would not imagine

Our products excel in the metals market due to the unmatched long life. This feature leads to more line uptime and fewer operating, maintenance, and unplanned downtime costs. Our products deliver increased fluid control and upgraded surface quality, as well as increased line speeds and decreased manufacturing costs. With a range of products for any price or performance constraint or necessity, NCCM can provide the right solution for any line.

Automotive

Blank and Coil Washing



Outstanding in long life and high precision oil film control

Excellent cleaning and oiling of blanks prevent costly quality errors later on in the stamping process. NCCM's nonwoven rolls last 2–5 times longer than any other nonwoven. Other products claiming to have long life will cease to perform well as time goes on, but NCCM nonwoven rolls maintain their initial "new roll" performance throughout their whole life (up to 5 regrinds). This consistently superior performance achieves oil film targets to the lowest requirement of below 1 g/m².

Industrial

Metals Processing and Materials Handling



Use the unique features of high-tech nonwovens to make your products better

NCCM nonwoven rolls lead multiple markets, and the same high performance is available for industrial applications. NCCM nonwoven rolls used in simple oiling applications provide a precise solution for previously uneven oil application and result in less oil waste. NCCM® V-Series (Wiper Bar II and Mill Wipes) and Specialty Felts bring excellent and long-lived service to various sweeping, wiping, and tanning applications. Whatever the material handling or industrial needs, find the solution with NCCM Company.



TECHNOLOGY

At NCCM, we are thrilled to be truly the global nonwoven roll technology leader. We are committed to the continuous improvement of current products and the innovative development of next-level technologies. Our dedication to product innovation and success is carried out through comprehensive technical testing, the continuous integration of feedback from our customers, maintaining a problem-solving mindset, and continual R&D, including regular strategic planning.

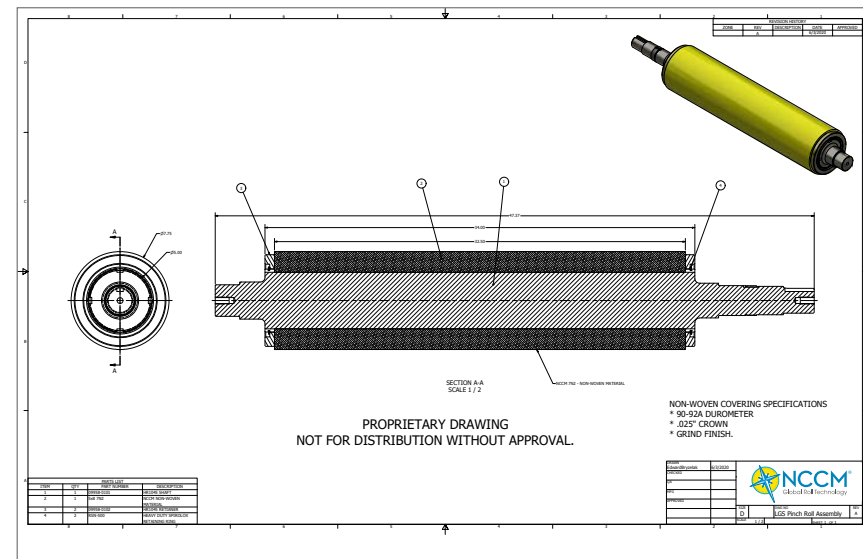

FROM PRE-SALES TECHNICAL SUPPORT TO AFTER-SALES SERVICES

NCCM offers custom engineering based on in-depth technical design competence. But our service does not end with a roll being supplied. Based on longstanding experience and broad technical know-how, we are ready to help hands-on and on-site with a precise alignment of our rolls and the settings to the individual machine requirements. On top of that, we offer customized after-sales services, from continuous rolls service reports to inventory tracking.

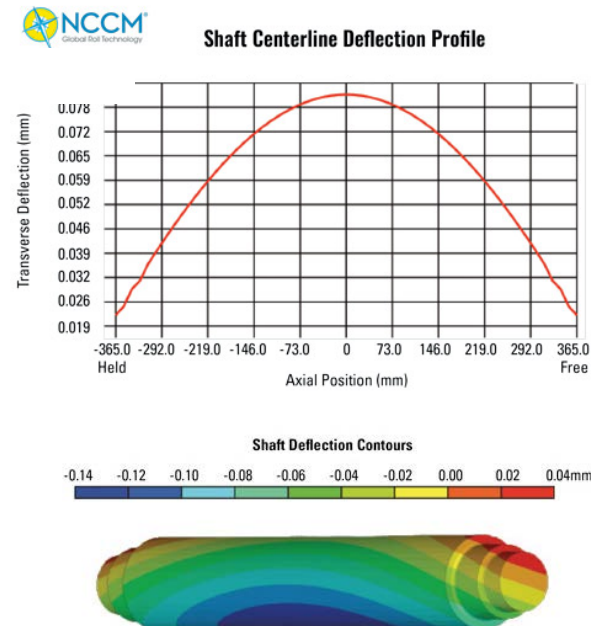

NONWOVEN ROLL MANUFACTURING AND SERVICE CAPABILITIES

NCCM's roll service centers in North America (Dearborn, MI/USA), Europe (Barcelona/Spain), and Asia (Shanghai/China) are equipped to provide the same unique roll quality standard worldwide and locally. Our lathes and CNC grinders allow us to completely manufacture and recondition everything from small wheels to large rolls to customer specifications. Our scope of supply includes:

- Application-specific nonwoven covers in different cost and performance categories
- Roll and wheel manufacturing, including shafts and accessories
- Reconditioning, recovering, and full service of worn-out roll and wheel covers

COMPLIMENTARY PRODUCTS

- Custom engineered shaft machining and fabrication
- Skate Wheel assemblies
- 3M Scotch-Brite™ and bristle brush rolls
- High-performance Brush Rolls for Automotive blank washers
- Fabricated steel roll storage boxes and racks
- Bearing block manufacturing and servicing
- Urethane and rubber rolls
- Leveler rolls, new and serviced (in North America only)



For more detailed information, scan the QR code or visit our website at NCCMCO.com



APPLICATIONS & PRODUCT PLACEMENT

Our products are grouped by features, allowing for a more concise understanding. The charts provided are meant to overview applications/positions in various lines and do not offer formal guarantees for any application or line requirements.



Product Portfolio	Product Category/Description	Applications/Positions
PREMIER	The Proven High-Value Nonwoven Roll The yellow original—outstanding in technical features, performance, and service life Premier Yellow	First choice TECH SOLUTION roll Outstanding in performance, features, and long life
	Value-Add Nonwoven Rolls Custom-engineered for multiple positions in coil & sheet processing	Multi-purpose roll to UPGRADE product and process qualities in multiple positions. UNIVERSAL and highly competitive OEM roll for new lines and positions.
	Cost competitive LOW-PRESSURE feeder or wringer ALTERNATIVE Roll for special VACUUM applications	SOFT TOUCH scratch avoidance and debris absorbing wringer roll for highly demanding metal surfaces
N-SERIES	Chemically-Resistant Nonwoven Rolls Advanced solutions for caustic, alkaline, and acidic applications	Long-life roll for CHEMICALLY-DEMANDING applications and positions
	Long-life roll for HIGHER PRESSURE AND TEMPERATURE demanding chemical applications and positions	Long-life roll for HIGHER PRESSURE AND TEMPERATURE demanding chemical applications and positions
	Long-Life Nonwoven Table and Bridle Rolls The replacement for rubber or urethane	Highly economic, competitive, and long-lasting REPLACEMENT for any heavy-wear RUBBER AND URETHANE rolls
R-SERIES	Technically advanced and long-life replacement for wear, scratch, or friction-critical BRIDLE rolls	Technically advanced and long-life replacement for wear, scratch or friction-critical BRIDLE rolls

This chart is meant to give an overview and does not provide formal guarantees for any application. Please contact an NCCM representative for further recommendations and technical support.

Product Portfolio	Product Category/Description	Lines
PREMIER	The Proven High-Value Nonwoven Roll The yellow original—outstanding in technical features, performance and service life Premier Yellow	First choice TECH SOLUTION roll Outstanding in performance, features and long life
	Value-Add Nonwoven Rolls Custom-engineered for multiple positions in coil & sheet processing	Multi-purpose roll to UPGRADE product and process qualities in multiple positions. UNIVERSAL and highly competitive OEM roll for new lines and positions.
	Cost competitive LOW PRESSURE feeder or wringer ALTERNATIVE Automotive feeder (roll) and roll for VACUUM applications	SOFT TOUCH scratch avoidance and debris absorbing wringer roll for highly demanding metal surfaces
N-SERIES	Chemically-Resistant Nonwoven Rolls Advanced solutions for caustic, alkaline and acidic applications	Long-life roll for CHEMICALLY-DEMANDING applications and positions
	Long-life roll for HIGHER PRESSURE AND TEMPERATURE demanding chemical applications and positions	Long-life roll for HIGHER PRESSURE AND TEMPERATURE demanding chemical applications and positions
	Long-Life Nonwoven Table and Bridle Rolls The replacement for rubber and urethane	Highly economic, competitive and long-lasting REPLACEMENT for any heavy-wear RUBBER AND URETHANE rolls
R-SERIES	Technically advanced and long-life replacement for wear, scratch or friction-critical BRIDLE rolls	Technically advanced and long-life replacement for wear, scratch or friction-critical BRIDLE rolls

This chart is meant to give an overview and does not provide any formal guarantees for any line. Please contact an NCCM representative for further recommendations and technical support.

For more detailed information, scan the QR code or visit our website at NCCMCO.com



Repairability Long Life High Coefficient of Friction Fluid Control

Product Use: All statements, technical information, and recommendations contained in this document are based on tests or experience that NCCM® believes are reliable. However, many factors beyond NCCM®'s control can affect the use and performance of an NCCM® product in a particular application, including conditions under which the product is used and the time and environmental conditions in which the product is expected to perform. Since these factors are uniquely within the user's knowledge and control, it is essential that the user evaluate the NCCM® product to determine whether it is fit for a particular purpose and suitable for the user's method of application.

Warranty and Limited Remedy: Unless stated otherwise in NCCM®'s product literature, packaging inserts, or product packaging for individual products, NCCM® warrants that each NCCM® product meets the applicable specifications at the time NCCM® ships the product. Individual products may have additional or different warranties as stated on product literature, package inserts, or product packages. NCCM® MAKES NO OTHER WARRANTIES, EXPRESS OR IMPLIED, INCLUDING BUT NOT LIMITED TO, ANY IMPLIED WARRANTIES OF MERCHANTABILITY OR FITNESS FOR A PARTICULAR PURPOSE OR ANY IMPLIED WARRANTY ARISING OUT OF A COURSE OF DEALING, CUSTOM OR USAGE OF TRADE.

The user is responsible for determining whether the NCCM® product is fit for a particular purpose and suitable for the user's application. If the NCCM® product is defective within the warranty period, your exclusive remedy and NCCM®'s and seller's sole obligation will be, at NCCM®'s option, to replace the product or refund the purchase price.

Limitation Of Liability: Except where prohibited by law, NCCM® and seller will not be liable for any loss or damage arising from the NCCM® product, whether direct, indirect, special, incidental, or consequential regardless of the legal theory asserted, including warranty, contract, negligence or strict liability.